

# Fixed Dome Outdoor Wall Mount

TR-JB07/WM03-F-IN

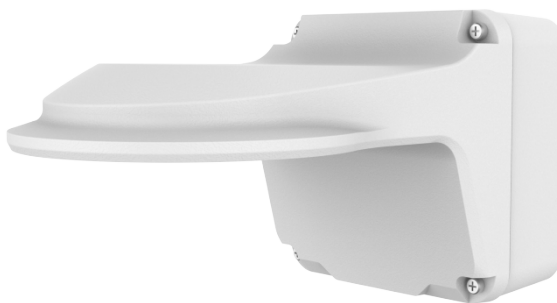

## Specifications

Model	TR-JB07/WM03-F-IN
Bracket	
Application	wall installation for IPC363X and IPC36XXS/E series fixed dome(Extra back outlet)
Bracket Dimensions	Φ125mm*125mm*233mm (4.92" x4.92"x9.17")
Bracket Weight	0.98kg(2.16lb)
Bracket Material	Aluminum alloy

## Dimensions

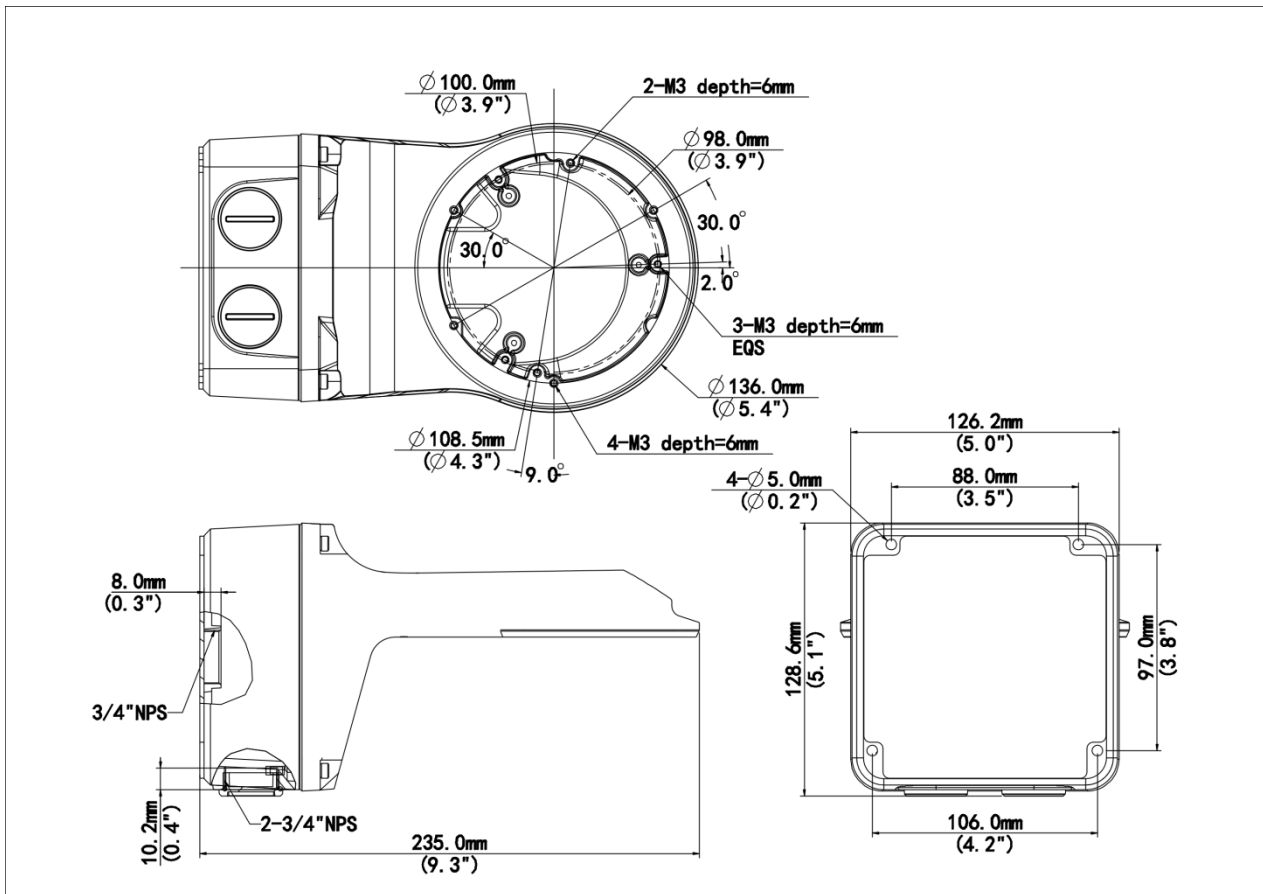

### Zhejiang Uniview Technologies Co., Ltd.

No. 369, Xietong Road, Xixing Sub-district, Binjiang District, Hangzhou City, 310051, Zhejiang Province, China (Zhejiang) Pilot Free Trade Zone, China

Email: [overseasbusiness@uniview.com](mailto:overseasbusiness@uniview.com); [globalsupport@uniview.com](mailto:globalsupport@uniview.com)

<http://www.uniview.com>

©2023-2025 Zhejiang Uniview Technologies Co., Ltd. All rights reserved.

\*Product specifications and availability are subject to change without notice.

\*Despite our best efforts, technical or typographical errors may exist in this document. Uniview cannot be held responsible for any such errors and reserves the right to change the contents of this document without prior notice.